

Ø 430

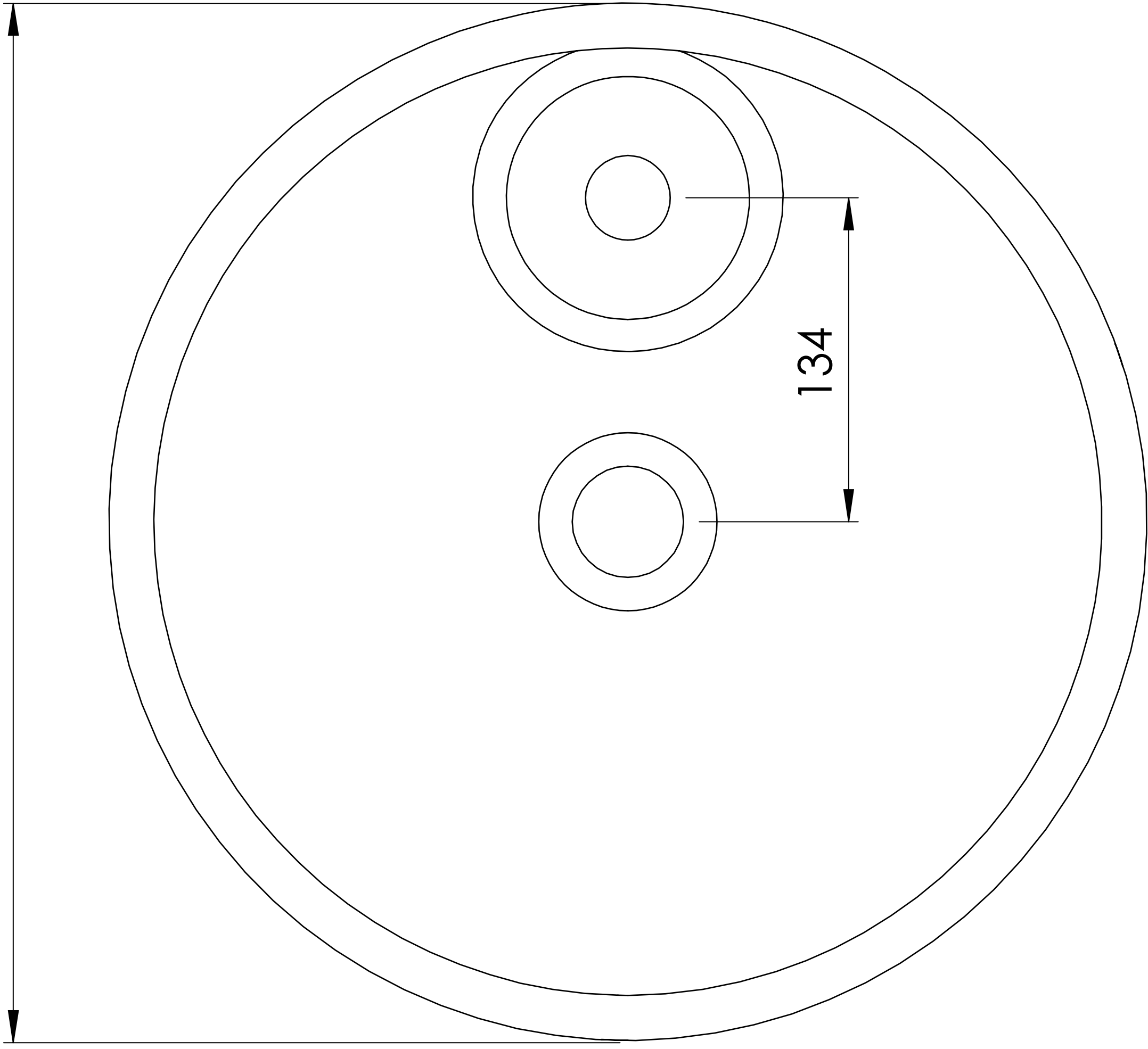

123

